

## Stereo Twin PAR Bar

LED PAR Bars with Foot Control

Item ref: 151.554UK

User Manual



Please read through this manual thoroughly before use, any damage caused by misuse of the product will not be covered by the warranty.



Please do not open the cover, contains high voltage.  
This product is not serviceable or repairable by the end user.  
Please refer to qualified personnel for service and repair.



## Safety Instructions

- Please keep this manual for future reference.
- Always make sure that you are connecting to the proper voltage, and that the line voltage you are connecting to is not higher than that stated on the bottom of the fixture.
- This product is intended for indoor use only. It must be connected to an earthed mains outlet.
- To prevent risk of fire or shock, do not expose fixture to rain or moisture. Make sure there are no flammable materials close to the unit while operating.
- The unit must be installed in a location with adequate ventilation, at least 20cm from adjacent surfaces. Be sure that no ventilation slots are obstructed.
- Always disconnect from power source before servicing or replacing fuse and be sure to replace with same fuse size and type.
- Maximum ambient temperature is 40°C. Do not operate the fixture at higher temperatures.
- In the event of a serious operating problem, stop using the unit immediately. Never try to repair the unit by yourself. Repairs carried out by unskilled people can lead to damage or malfunction. Please contact the nearest authorised technical assistance centre.
- Make sure the power cord is never crimped or damaged.
- Never disconnect the power cord by pulling or tugging on the cord.
- Avoid direct eye exposure to the light source while it is on.

## Contents in the box

- PAR Bar x2
- Tripod stand x2
- Foot Controller
- Remote control
- Carry Case for Par Bar and Foot control
- Carry case for tripod x2
- Instruction Manual
- Power cable x2
- 10M DMX cable
- Hanging Bracket and Screw Set x4

## Features

- Twin PAR Bar lighting set with 2x2x5pcs 10W Quad LEDs
- High output with 3255Lux at 2M when full on with one separate head
- Saturated wash effect without multicoloured shadows
- Foot controller with 10M cable and IR remote control
- Separate light head control with various built-in colour macros
- Easy setup and tear-down with tripod stand and carrying bags

## Specification

- Power supply 220-240 Vac, 50/60Hz (IEC)
- Fuse rating 2A
- Power consumption 200W
- IP rating IP20
- Cooling Fan
- LED Type 10W RGBW 4in1 LED x 20pcs
- Colour Temp. 8000K
- Average life span 50,000 Hours
- Standard beam angle 25°
- Dimming 0-100%
- Luminance 3255Lux @2M per head
- Strobe 1-25 Hz
- Dimension
  - PAR bar 600x245x65mm
  - Stand Compact 140x110x1025
    - Height extension 1140 – 1870mm
  - Foot Controller 420x155x38mm
  - Main Carry Case 660x300x220mm
- Weight
  - Overall 18Kg
  - Main Carrier with contents 12Kg
  - Stand in carrier 3.0Kg

○

## Setup/Installation

This lightweight, versatile PAR bar system is perfect for mobile DJs and performers who need their lighting to be quick to set up and easily transportable. 4 PAR Cans are each loaded with 5 LEDs in red, green, blue and white for super smooth colour blending.

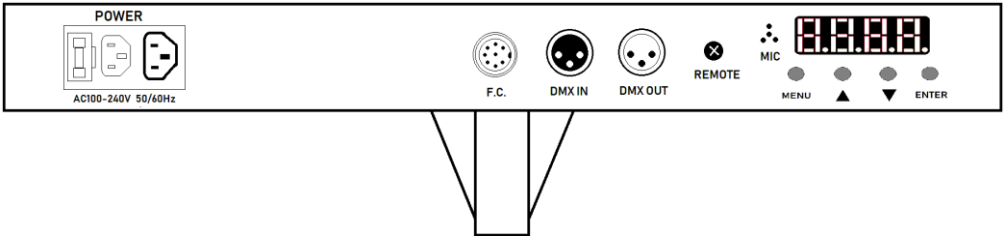

1. Remove stands from the carrier and open the tripod legs onto the floor, make sure it is on a stable footing.
2. Remove the PAR bars from the main carrier and attach them onto the tripod stand.
3. Tighten the screw to secure the PAR bar.
4. Connect the Power cables on both units.
5. Setting the PAR BARS to Master and Slave (see PAR Bar mode settings.)
6. Connect the multi-core lead to the foot controller and the Master unit.
7. Connect the XLR cable (3 Pins) to the **DMX OUT** socket on the Master unit and the **DMX IN** socket on the Slave unit.
8. Adjust height of the extension pole, insert safety pin and tighten the locking screw.
- 9.

Hanging Brackets are included for permanent fitting on trusses (Truss attachments are not included) or screw to the ceilings. Attach bracket with screw onto the ends of the PAR bar as shown: -

## Bracket Assembly

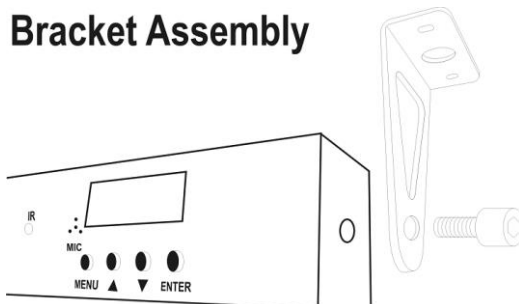

## PAR Bar Mode Setting

When using the unit for the first time or resetting to default, it is recommended a factory default reset is performed.

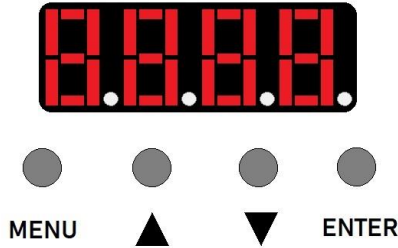







### Factory Default Setting: -

1. Press the **MENU** button once, display will show **Addr**.
2. Press **UP** button once, display will show **DEF**.
3. Press the **Enter** button once, display will show **000**. This means that you have set unit to Default setting, the unit now is in Slave mode.

## Function Menu Table

Below is a table showing the options and settings available for the PAR Bar, Press the **MENU** button once and you can scroll the function list in the order as shown. Press the **Enter** button once to access the range setting, then pressing **Up/Down** buttons allows you to adjust the setting, press enter to select or Menu to exit.

Function	Display	Range	Feature
Address	Addr	A001-A512	DMX512 addressing
Channel	Chnd	06ch 09ch 10ch 13ch	6 DMX Channels 9 DMX Channels 10 DMX Channels 13 DMX Channels
Show Mode	Shnd	Sh01-sh04	Modes 1-4
Slave/Master	SlMst	SL 1 MAst	Slave Mode Master Mode
Non DMX	SLnd	auto soun blac hold	Auto Sound Black Out Hold

Speed		SP01-SP99	Speed Adjust
Sensitivity		S001-S099	Sound Sensitivity
Mirroring		On/Off	Mirroring Mode
Display		On/Off	Display Reverse
Time		001H	Shows Working Time
Version		V1.1	Shows Software Version
Factory Default		A001	Enter Factory Default Setting

## Foot Controller

To use the Foot Controller, it must be connected to the PAR Bar set as the Master and switch on the power at the back of the Foot Controller. When a DMX controller is connected to the PAR Bar it overrides the foot controller.

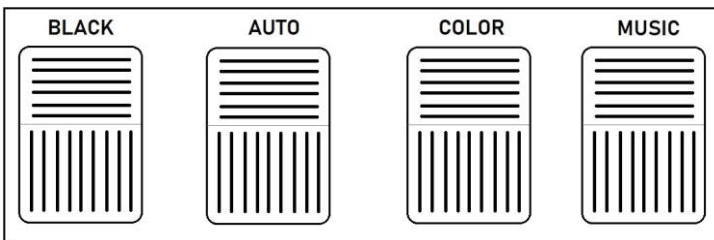

Pedal	Function
BLACK	Press once - Black Out Mode Press and Hold – (On Auto Mode only) Strobe feature is activated while it is held down.
AUTO	Auto Mode – perform preprogrammed schemes
COLOR	Colour Mode -
MUSIC	Sound Mode – The rhythm of the light will be synced to the sound picked up by the mic.

## Remote Control

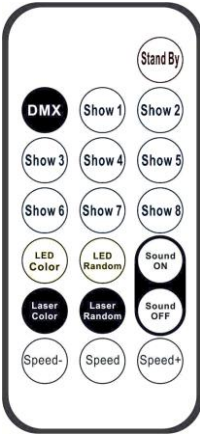

Button	Functions
Stand By	Power On/Off
DMX	DMX mode
Show 1	Show 1
Show 2	Show 2
Show 3	Show 3
Show 4	Show 4
Show 5	Show 5
Show 6	No function
Show 7	No function
Show 8	No function
Led Color	LED color Jump
LED Random	No function
Sound on	Sound on
Laser color	No function
Laser Random	No function
Sound Off	Sound off
Speed-	Show1-show4 speed increase
Speed	Show1-show8 speed in middle(default)
Speed+	Show1-show8 speed decrease

## DMX Connection and Control

The PAR Bar can be connected as a daisy chain by using standard XLR cables. The units are labelled with **DMX IN** and **DMX OUT** –

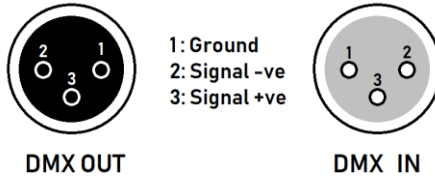

Connect the DMX controller output to the **DMX IN** on the first unit. Then connect the first unit's **DMX OUT** to **DMX IN** on the next unit, and so on if there are more units. A DMX starting address must be assigned to each fixture; allowing the DMX controller to control each fixture individually. This fixture has 13 channels so the first unit should be assigned with an address of 001, the next unit should be 014 (13+1) and next one at 027 (2x13+1) etc. All fixtures can be set to the same address, this way all connected the fixtures will be act in unison. Please refer to the DMX tables for the function and features.

## DMX Terminator

If there are many lines or lights, it is recommended to use a DMX terminator to prevent DMX signal corruption, the DMX terminator is an simple XLR plug with a 120  $\Omega$  resistor connected between pins 2 and 3, which is then plugged into the output XLR socket of the last fixture in the chain.

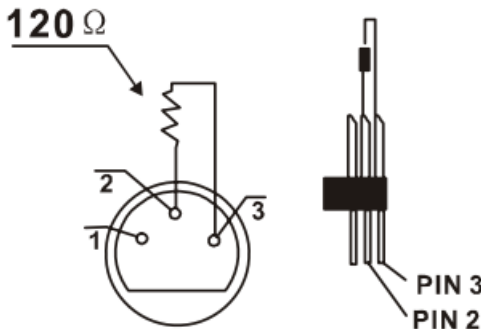



## DMX Control Table

### 6CH Mode

Channel	Function	Value	Description
1CH	Master dimmer	0-255	Master dimmer
2CH	Strobe	000-015	OFF
		016-030	ON
		031-090	Variable strobe from slow to fast
		091-105	on
		106-165	Pulse effect from slow to fast
		166-180	on
		181-240	Random strobe from slow to fast
		241-255	on
3CH	Red dimmer	0-255	Red dimming
4CH	Green dimmer	0-255	Green dimming
5CH	Blue dimmer	0-255	Blue dimming
6CH	White dimmer	0-255	White dimming

## 9CH Mode

Channel	Function	Value	Description
1CH	Master dimmer	0-255	Master dimmer
2CH	Strobe	000-015	OFF
		016-030	ON
		031-090	Variable strobe from slow to fast
		091-105	on
		106-165	Pulse effect from slow to fast
		166-180	on
		181-240	Random strobe from slow to fast
		241-255	on
3CH	Red dimmer	0-255	Red dimming
4CH	Green dimmer	0-255	Green dimming
5CH	Blue dimmer	0-255	Blue dimming
6CH	White dimmer	0-255	White dimming
7CH	Color macro	0-15	No function
		16-175	Color mixing
		176-255	Color fading from slow to fast
8CH	Show mode	0-15	No function
		16-63	Show 1
		64-111	Show 2
		112-159	Show 3
		160-207	Show 4
		208-255	Show 5
9CH	Speed	0-250	Sound off, Auto Speed from slow to fast
		251-255	Sound On

## 10CH Mode

Channel	Function	Value	Description
1CH	Master dimmer	0-255	Master dimmer
2CH	Strobe	000-015	OFF
		016-030	ON
		031-090	Variable strobe from slow to fast
		091-105	on
		106-165	Pulse effect from slow to fast
		166-180	on
		181-240	Random strobe from slow to fast
		241-255	on
3CH	Red 1 dimmer	0-255	Red1 dimming
4CH	Green1 dimmer	0-255	Green1 dimming
5CH	Blue1 dimmer	0-255	Blue1 dimming
6CH	White1 dimmer	0-255	White1 dimming
7CH	Red 2 dimmer	0-255	Red2 dimming
8CH	Green2 dimmer	0-255	Green2 dimming
9CH	Blue2 dimmer	0-255	Blue2 dimming
10CH	White2 dimmer	0-255	White2 dimming

## 13CH Mode

Channel	Function	Value	Description
1CH	Master dimmer	0-255	Master dimmer
2CH	Strobe	000-015	OFF
		016-030	ON
		031-090	Variable strobe from slow to fast
		091-105	on
		106-165	Pulse effect from slow to fast
		166-180	on
		181-240	Random strobe from slow to fast
		241-255	on
3CH	Red1 dimmer	0-255	Red1 dimming
4CH	Green1 dimmer	0-255	Green1 dimming
5CH	Blue1 dimmer	0-255	Blue1 dimming
6CH	White1 dimmer	0-255	White1 dimming
7CH	Red2 dimmer	0-255	Red2 dimming
8CH	Green2 dimmer	0-255	Green2 dimming
9CH	Blue2 dimmer	0-255	Blue2 dimming
10CH	White2 dimmer	0-255	White2 dimming
11CH	Color macro	0-15	No function
		16-175	Color mixing
		176-255	Color fading from slow to fast
12CH	Show mode	0-15	No function
		16-63	Show 1
		64-111	Show 2
		112-159	Show 3
		160-207	Show 4
		208-255	Show 5
13CH	Speed	0-250	Sound off, Auto Speed from slow to fast
		251-255	Sound On



This product is classed as Electrical or Electronic equipment and should not be disposed with other household or commercial waste at the end of its useful life.  
The goods must be disposed of according to your local council guidelines