

GARDEN LASERS

User Manual

 Caution: Please read this manual carefully before operating
Damage caused by misuse is not covered by the warranty

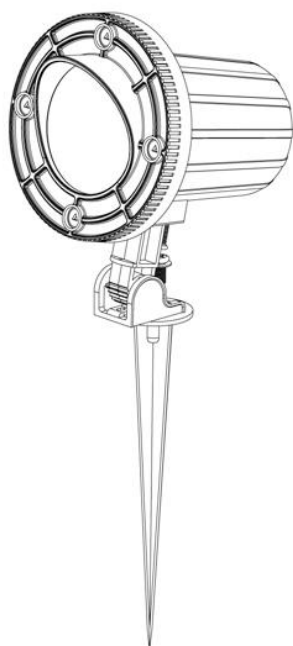

WARNING This item contains laser radiation, no user serviceable/repairable parts within. Please refer to licensed electrician to perform any required repair or maintenance. Please strictly following the laser health and safety guidelines HSG95.





For detailed information regarding HSG95 go to...
<http://www.hse.gov.uk/pubns/books/hsg95.htm>

Laser Safety Warnings

1. Avoid direct eye contact with the laser light. Never intentionally shine the laser beam in your eyes or the eyes of any others. It can potentially cause instant injury or blindness.
2. Do not open laser housing under any circumstances.
3. Do not point onto any on-coming pedestrians, vehicles or traffic routes from land, sea or air.
4. Laser should not be projected at or within the flight path of an aircraft. If your intended surface is within 10 nautical miles of an airport, lower the angle so that no lasers point to the sky.
5. Children should be supervised to ensure they do not play with the unit. It is not a toy.

Electric Safety Instructions

 Please do not open the cover, contains high voltage. This product is not serviceable or repairable by the end user. Please refer to qualified personnel for service and repair. 

When using electrical products, basic precautions should always be practiced

1. Read and follow all instructions.
2. Only qualified personnel can carry out the electrical installation work in accordance with all applicable codes and standards including fire rated constructions.
3. Keep the mains power connection protected from moisture and the elements.
4. Ensure power cable and plug are in good condition.
5. Do not disassemble the adaptor, risk of electric shock or fire.

Components

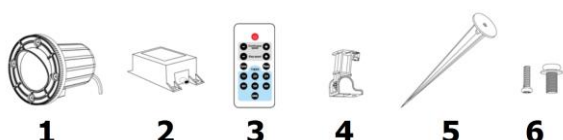

- | | | | |
|---|-----------------------|---|--------------------------|
| 1 | Laser Projection Unit | 4 | Angle adjustment bracket |
| 2 | AC Power Adaptor | 5 | Ground spike |
| 3 | Remote control | 6 | Screws x 2 |

Assembly

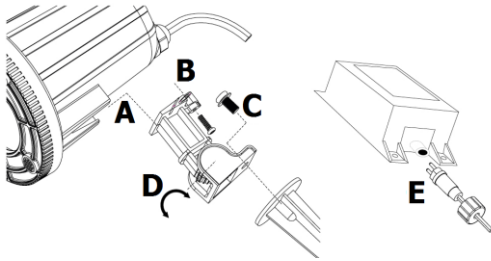

Remove all components from packaging (save the packaging for storing the garden laser when not in use)
 Choose the intended surface which the laser light will project onto.
 Determine the projection location of the unit for installation and ensure it is free from any visual obstructions.
 Push the spike into the ground (depending on the firmness of the ground, you may need to use a mallet to insert the spike completely. Do not use your foot!)
 Attach the angle adjustment bracket to the bottom of the laser as shown above (A).
 Use the correct screw to fix bracket (B).
 Screw the angle adjustment bracket to the ground spike using the correct screw (C).

Adjust the angle of the laser head (D).

Attach the 2-pin lead to the AC power adaptor (E). This will only go in one-way, do not force the connector.

Once the 2-pin lead has been fully inserted, screw the cap into place to ensure a weatherproof seal.

Plug the AC adaptor into the mains to start the laser light.

With great care and avoiding looking directly at the laser adjust the angle to the required position. Tighten all screws if required.

Remote Control

The remote has an effective range of 15 metres (50 feet). This will be reduced if there are obstacles. Only the speed settings of the laser unit will be saved if you disconnect the unit from the mains or switch off via the power button on the remote.

All settings will be saved automatically if you are using the timer settings to switch off the unit. It will start up on the same program as when the timer which the unit off. Take care not to lose the remote, it's the only way you have of adjusting the laser unit!

1. Power button – Start or Stop the laser (unplug power if not being used for long periods)
2. Continuous Speed – 6 different rotational speeds available (including static).
3. Step Speed – 6 different speed/step settings.
4. Colour – Select a single colour or a combination of colours.
5. Flash – 3 settings.
6. Timer – The timer will automatically switch off after the duration selected. The unit will automatically switch on at the same time the following day. E.G. If you get you set the timer at 5pm for 6 hours, the laser will switch off at 11pm and switch on again at 5pm the following day. Pressing "CANCEL" will cancel the timer setting so the laser unit can be switched on/off manually.

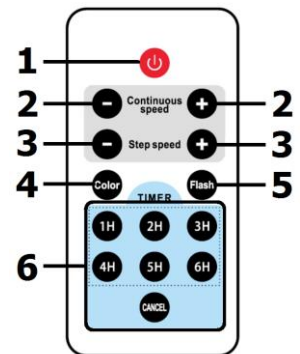

Activating the remote – A CR2025 battery is already in your remote unit. Remove the plastic insulation tab. This will enable the remote to work. If the remote isn't going to be used for a long period of time, it is advisable to reinsert the plastic tab to save battery life.

Helpful Hints

- Do not use with dimmers.
- For extended lifetime, let the unit cool down for 30 mins every 6 hours.
- Operating temperature are between -20°C and 35°C. There may be a longer warm-up time in low temperatures.
- The laser will look brightest in the dark but will be less bright if competing with another light source.

Specifications

Power supply	12Vdc, 500mA (adaptor supplied)
IP rating	IP65
Warm up time	2 - 5 minutes
Laser class	3R
Power lead length	4.8m
Housing material	Aluminium
Operating temperature range	-20 to 35°C
Dimensions	100 x 100 x 130mm
Weight	1kg
Laser safety standard	BSEN62471:2008



Disposal: The "Crossed Wheelie Bin" symbol on the product means that the product is classed as Electrical or Electronic equipment and should not be disposed with other household or commercial waste at the end of its useful life. The goods must be disposed of according to your local council guidelines.

*Errors and omissions excepted.
 Copyright© 2017. AVSL Group Ltd.*