

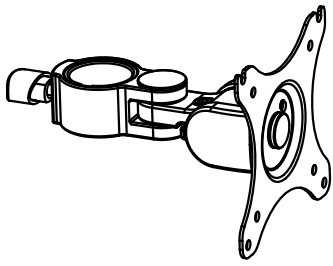







**Item No.:PMB100**

Installation guide



-   
**M4x12MM A(4PCS)**
-   
**M5x12MM B(4PCS)**
-   
**φ6.5xφ13x2 C(8PCS)**
-   
**5X5MM D(1PC)**
-   
**E(1PC)**
-   
**F(1PC)**
-   
**2.5X2.5MM G(1PC)**

Mount Bracket (1PC)

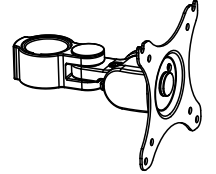

- VESA**  
75x75  
100x100
-   
17°-30°
-   
max  
10kg
-   
-85° ~15°



## STEP 1

Attaching thumbscrew to bracket

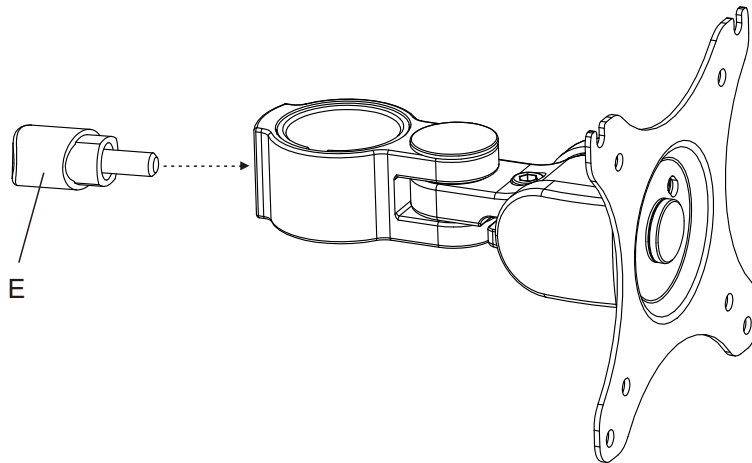

## STEP 2

Attaching bracket to screen

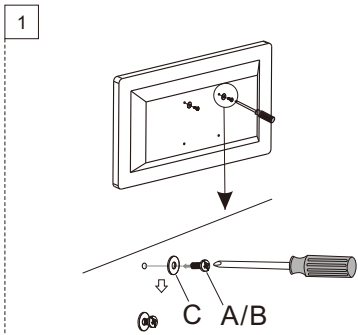

Increase no of washers based on screen requirements

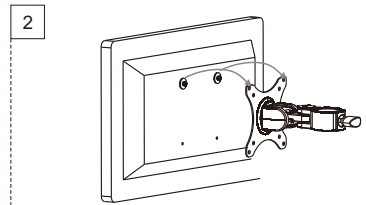

Secure the top fixing screws to the screen using the fixings provided

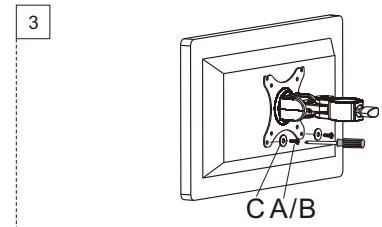

Secure the bottom fixing screws to the screen using the fixings provided

## STEP 3

Fixing screen and bracket to 35mm pole

Fix the screen and bracket to a suitable 35mm pole mounting and ensure the thumbscrew is securely tightened.

Finally lock the bracket in place using locking collar (F)

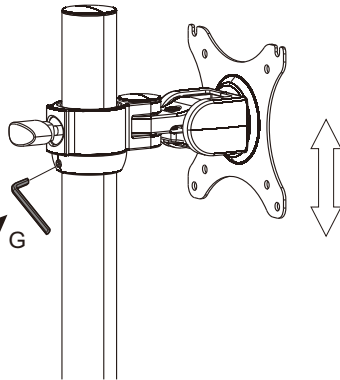

5x5mm  
D

2.5x2.5mm  
G

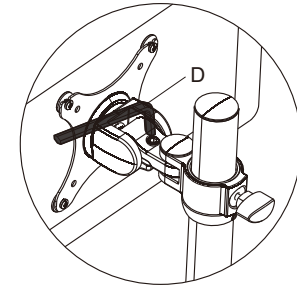

To adjust the screen angles use the 5x5 allen key supplied



### CAUTION

- This product contains small items that could be a choking hazard if swallowed. Please keep away from young children.
- Make sure these instructions are read and completely understood before attempting installation. If you are unsure of any part of this installation please contact a professional installer for assistance.
- The 35mm mounting pole must be capable of supporting the combined weight of the mount and the display.
- Please check all joints every 2 months, making sure all screws remain securely fastened.
- Never exceed the maximum load capacity of 10Kg, or it may result in product failure or personal injury.

**Note:** this product is intended for indoor use only. Use of this product outdoors could lead to product failure or personal injury.