

14 Inch Tabletop Charcoal Grill

Item ref: 799.045UK

User Manual

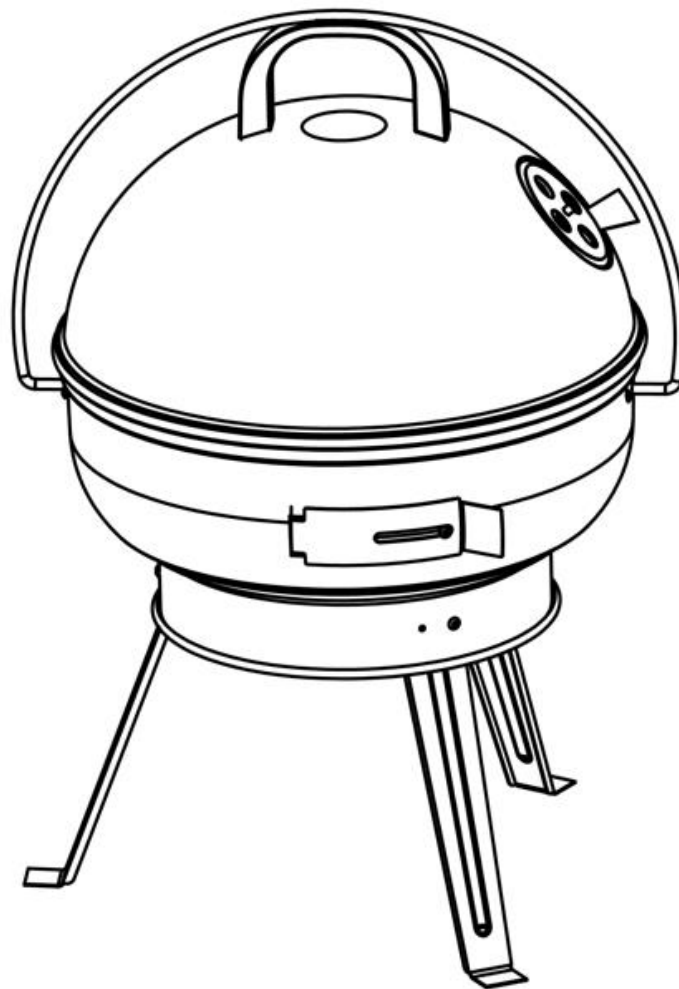











Assembly and Safety Instructions

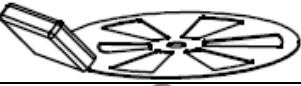

Read all instructions before use

- FOR OUTDOOR USE ONLY -

Parts List

ITEM	QTY	DESCRIPTION	Pictures
1	1	Legs Assembly	
2	1	Bowl	
3	2	Bowl Vents	
4	1	Top Lid	
5	1	Lid Handle	
6	1	Cooking Grid	
7	1	Charcoal Grid	
8	1	Wire Handle	
9	1	Lid Vent (full set)	
A	4	M5X12 SCREW	
B	4	Medium Wing Nut M5	
C	2	Larger Wing Nut M6	

To Assemble:

Attention! The BBQ grill must be installed on a secure level base prior to use.

Step 1:

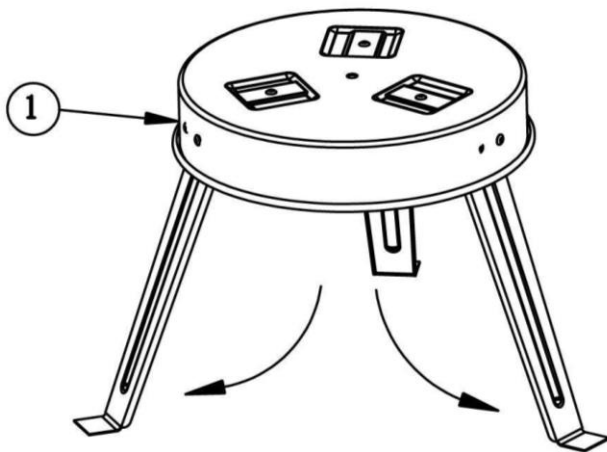

Step 2:

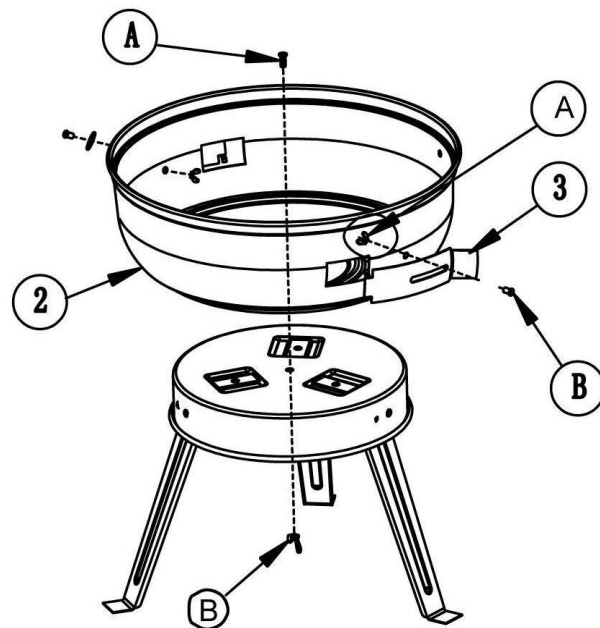

Step 3:

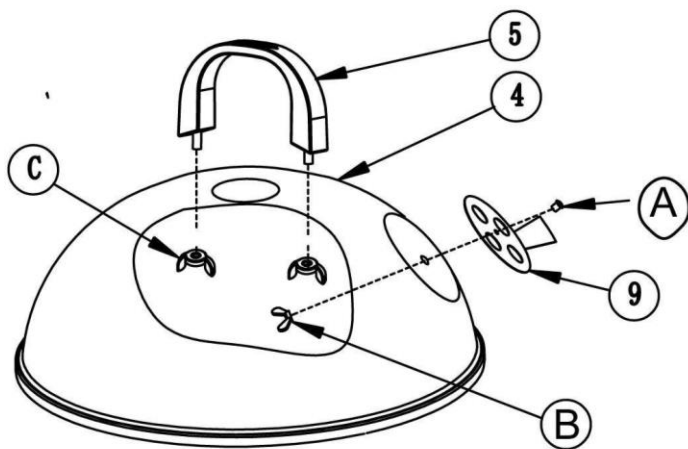

Step 4:

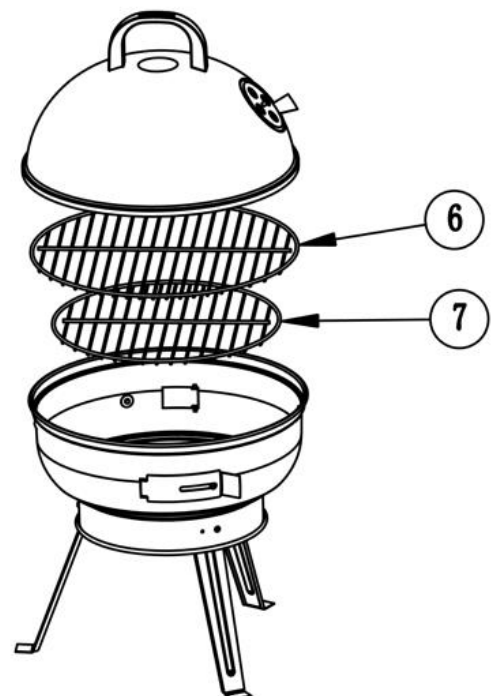

Step 5:

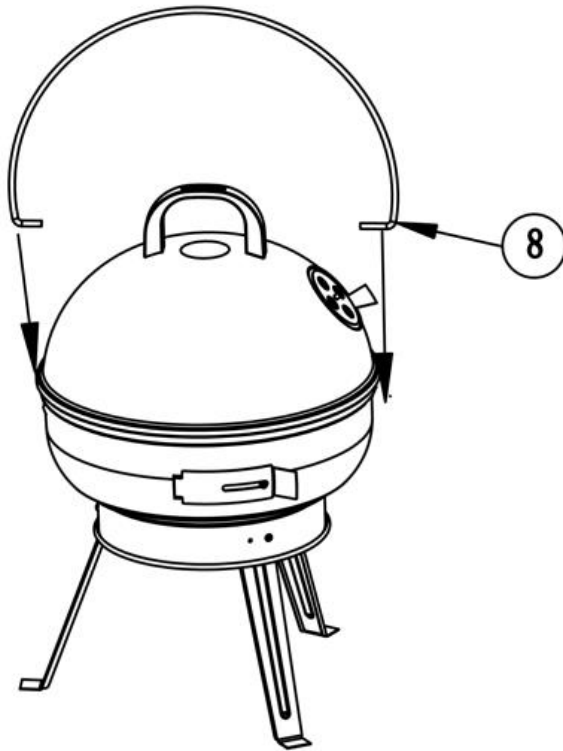

Step 6:

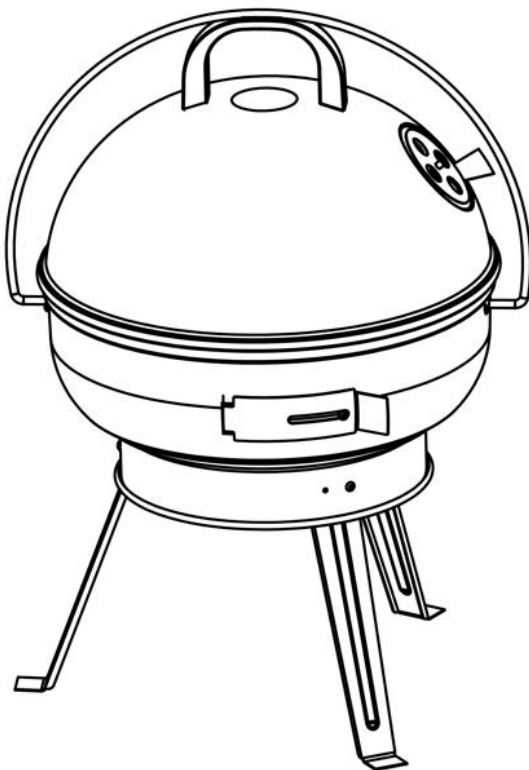

To Use:

1. Choose an open site at least 10 feet away from any building or combustible materials. The BBQ grill must be installed on a secure level base prior to use.
2. Add charcoal (no more than 1.2kg <2,65lb>) into a charcoal holder (not included) and ignite the charcoal. If you use charcoal lighter fluid, please use it according to the lighter fluid manufacturer's instructions.
3. Remove the cooking grid (6) and put the lighted charcoal from the holder onto the charcoal grid (7) to form a pile.
*** Do not ignite the charcoal in the barbeque grill directly!**
4. Spread hot coals once they have mostly turned grey.
5. Place the cooking grid (6) onto the bowl (2). Wait until the cooking grid gets hot enough. Do not cook before the fuel has a coating of ash. The BBQ grill shall be heated up and the fuel kept red hot for at least 30 minutes prior to the first cooking on the barbecue.
6. Place food on the cooking grid and cook until done.
7. Use protective gloves or mitts to protect hands while cooking or adjusting air vents.
8. Use protective BBQ tools with long and heat resistant handles.
9. After use, put the lid over the bottom and close the air vent to extinguish the charcoal. Do not use water.
10. Make sure the charcoal is fully extinguished and cooled down before removing the ashes from the bottom of the grills.
11. Make sure the BBQ grill is completely cooled down before moving or storage.

Safety Warning

- Attention! This BBQ will become very hot, do not move it during operation.
- Do not use indoors.
- CAUTION! Do not use spirit or petrol for lighting or re-lighting.
- WARNING! Keep away from children and pets.
- Never leave the BBQ grill unattended while it is in use